





INVESTITOR: HRVATSKE AUTOCESTE d.o.o. 10 000 ZAGREB, ŠIROLINA 4	KNJIGA:	SADRŽAJ:  SITUACIJA	
NARUČITELJ: HRVATSKE AUTOCESTE d.o.o. 10 000 ZAGREB, ŠIROLINA 4	GLAVNI PROJEKTANT: mr.sc. KRUNOSLAV MAVAR, dipl.ing.građ. 	BROJ PROJEKTA: 72180-IZV-215/21	
GRAĐEVINA: MOST ŽUTICA U KM 66+174 NA AUTOCESTI A3		MJERILO: 1:500	DATUM: svibanj, 2021.
VRSTA PROJEKTA: IZVEDBENI GRAĐEVINSKI PROJEKT	SURADNIK: DOROTEA SREMEC, mag. ing. aedif.	ARHIVSKI BROJ: IZV-215/21	BROJ PRILOGA: 1.
		OZNAKA DOKUMENTA: 72180-IZP-215-21_MOST ŽUTICA	

# FAZA UKLANJANJA - LIJEVI OBJEKT

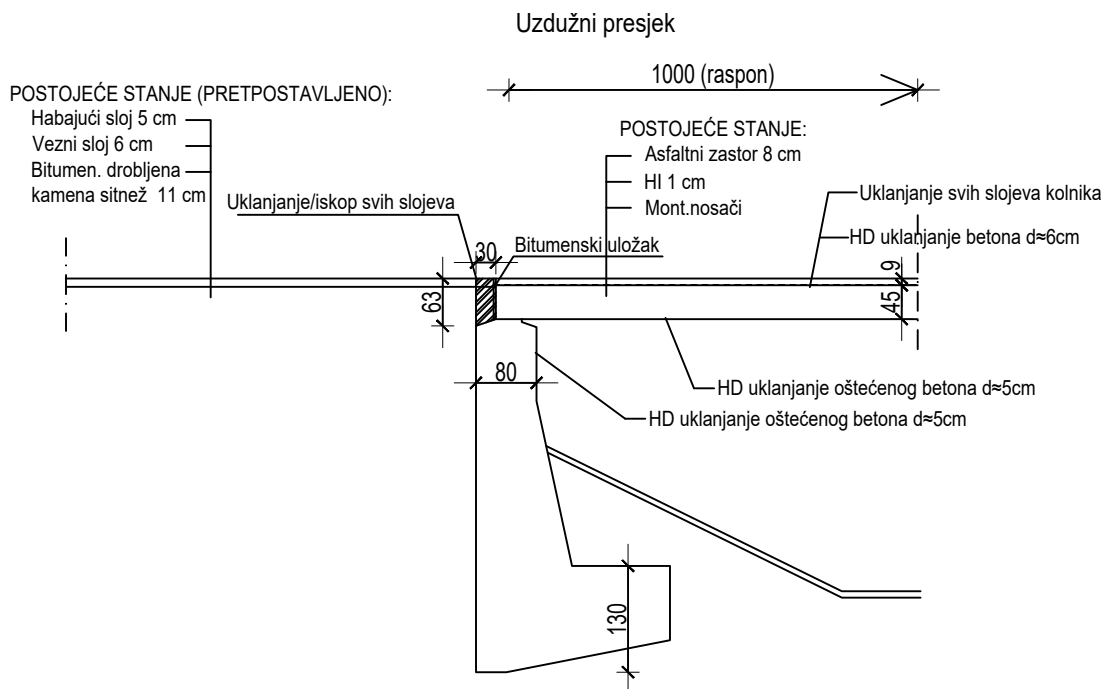
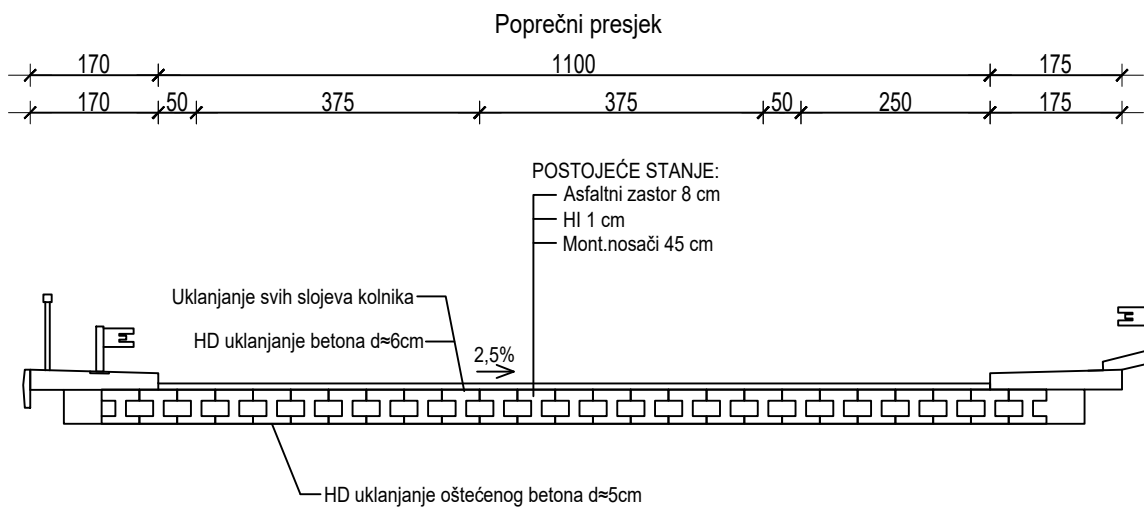

INVESTITOR: HRVATSKE AUTOCESTE d.o.o. 10 000 ZAGREB, ŠIROLINA 4	KNJIGA:	SADRŽAJ: FAZA UKLANJANJA - LIJEVO	
NARUČITELJ: HRVATSKE AUTOCESTE d.o.o. 10 000 ZAGREB, ŠIROLINA 4	GLAVNI PROJEKTANT: mr.sc. KRUNOSLAV MAVAR, dipl.ing.grad.	BROJ PROJEKTA: 72180-IZV-215/21	
GRADEVINA: MOST ŽUTICA U KM 66+174 NA AUTOCESTI A3		MJERILO: 1:100	DATUM: svibanj, 2021.
VRSTA PROJEKTA: IZVEDBENI GRADEVINSKI PROJEKT		SURADNIK: DOROTEA SREMEC, mag. ing. aedif.	ARHIVSKI BROJ: IZV-215/21
		OZNAKA DOKUMENTA: 72180-IZP-215-21_MOST ŽUTICA	

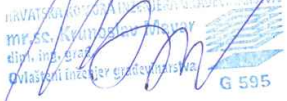
# FAZA UKLANJANJA - DESNI OBJEKT

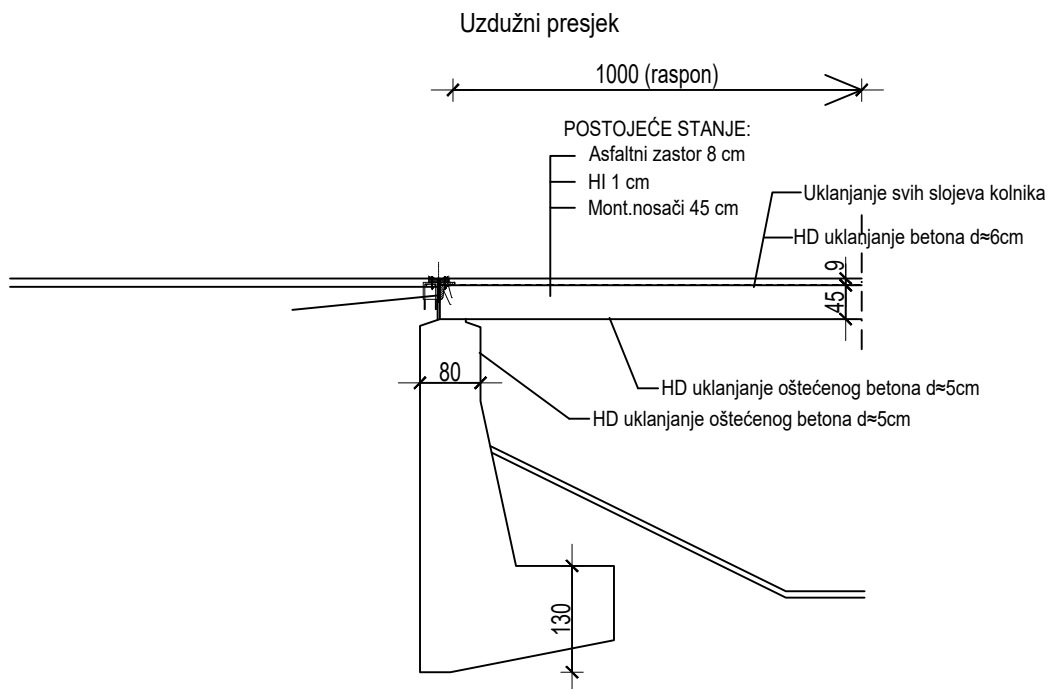
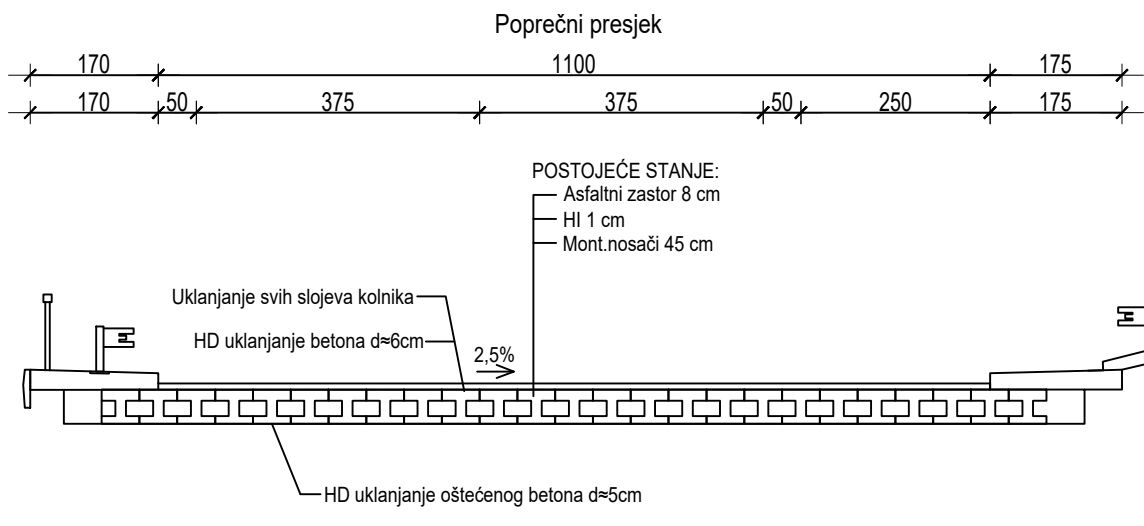

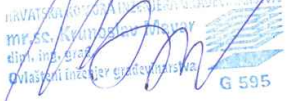
INVESTITOR: HRVATSKE AUTOCESTE d.o.o. 10 000 ZAGREB, ŠIROLINA 4	KNJIGA:	SADRŽAJ: FAZA UKLANJANJA - DESNO	
NARUČITELJ: HRVATSKE AUTOCESTE d.o.o. 10 000 ZAGREB, ŠIROLINA 4	GLAVNI PROJEKTANT: mr.sc. KRUNOSLAV MAVAR, dipl.ing.grad.	BROJ PROJEKTA: 72180-IZV-215/21	
GRADEVINA: MOST ŽUTICA U KM 66+174 NA AUTOCESTI A3		MJERILO: 1:100	DATUM: svibanj, 2021.
VRSTA PROJEKTA: IZVEDBENI GRADEVINSKI PROJEKT		SURADNIK: DOROTEA SREMEC, mag. ing. aedif.	ARHIVSKI BROJ: IZV-215/21
		OZNAKA DOKUMENTA: 72180-IZP-215-21_MOST ŽUTICA	

## FAZA UGRADNJE - LIJEVI OBJEKT

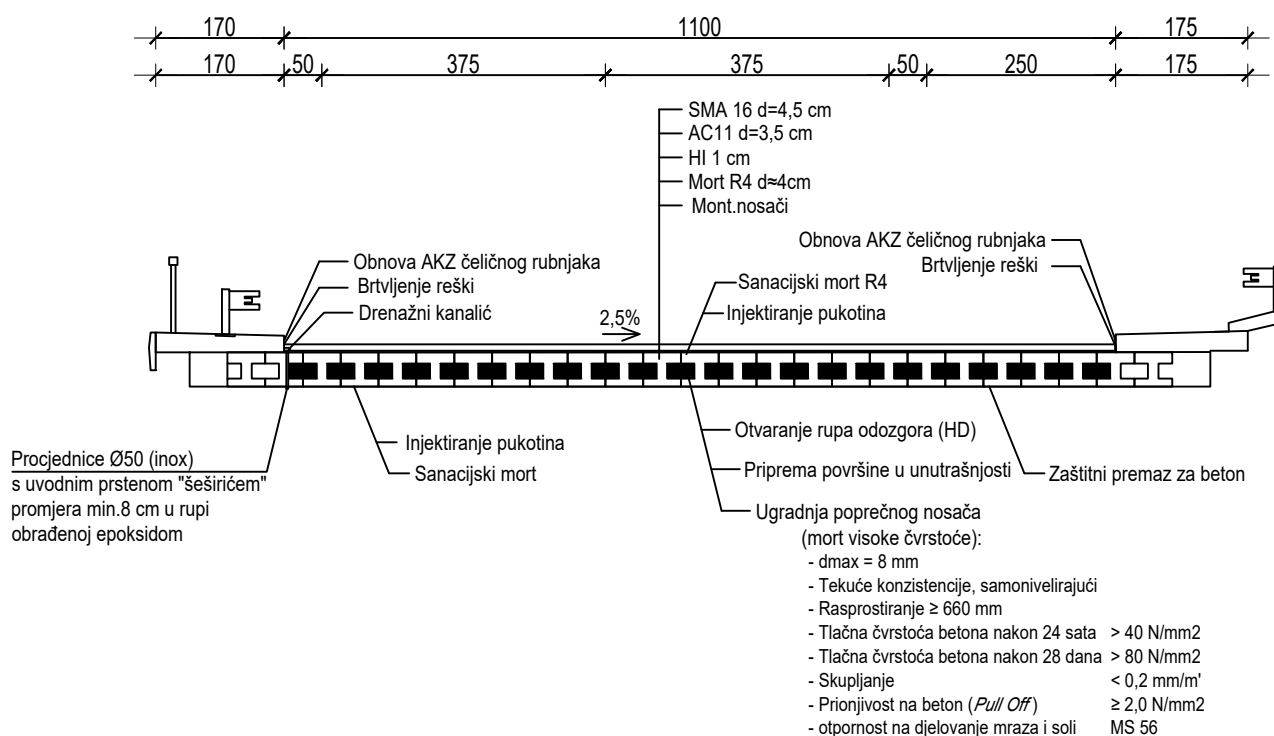

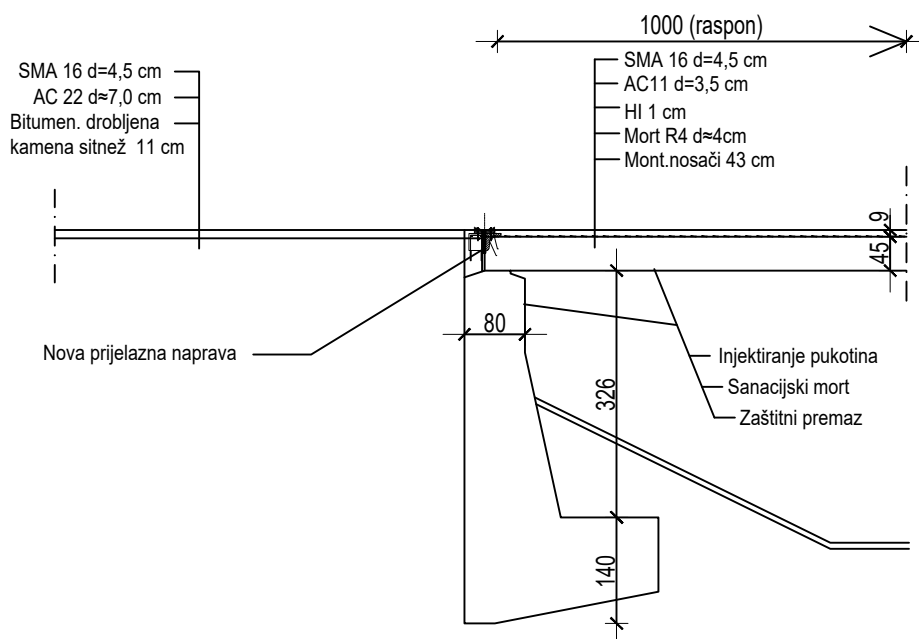

### Uzdužni presjek



INVESTITOR: <b>HRVATSKE AUTOCESTE d.o.o.</b> 10 000 ZAGREB, ŠIROLINA 4	KNJIGA: GLAVNI PROJEKTANT: mr.sc. KRUNOSLAV MAVAR, dipl.ing.grad.	SADRŽAJ: <b>FAZA UGRADNJE - LIJEVO</b>	 INSTITUT IGH ZAVOD ZA PROJEKTIRANJE
NARUČITELJ: <b>HRVATSKE AUTOCESTE d.o.o.</b> 10 000 ZAGREB, ŠIROLINA 4		BROJ PROJEKTA: <b>72180-IZV-215/21</b>	
GRAĐEVINA: <b>MOST ŽUTICA U KM 66+174 NA AUTOCESTI A3</b>		MJERILO: <b>1:100</b>	DATUM: <b>svibanj, 2021.</b>
VRSTA PROJEKTA: <b>IZVEDBENI GRAĐEVINSKI PROJEKT</b>	SURADNIK: DOROTEA SREMEC, mag. ing. aedif.	ARHIVSKI BROJ: <b>IZV-215/21</b>	BROJ PRILOGA: <b>4.</b>
		OZNAKA DOKUMENTA: 72180-IZP-215-21_MOST ŽUTICA	

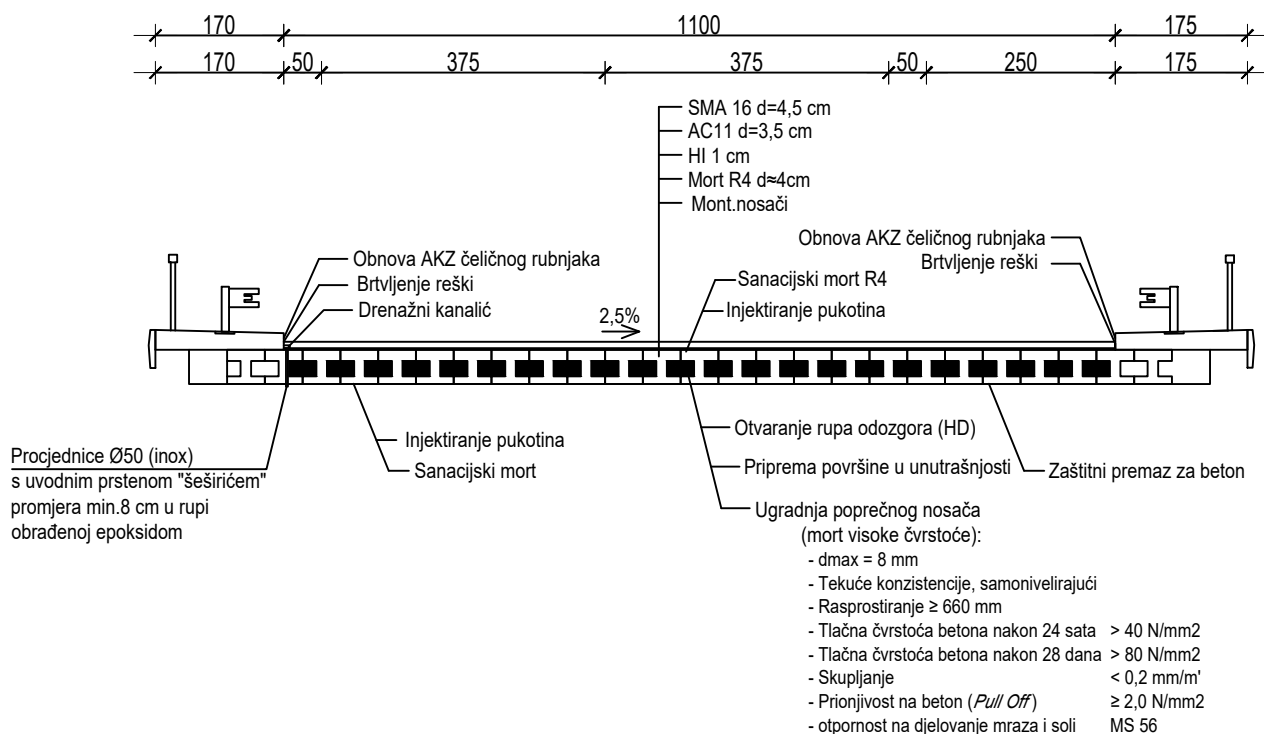

## FAZA UGRADNJE - DESNI OBJEKT - POPREČNI PRESJEK

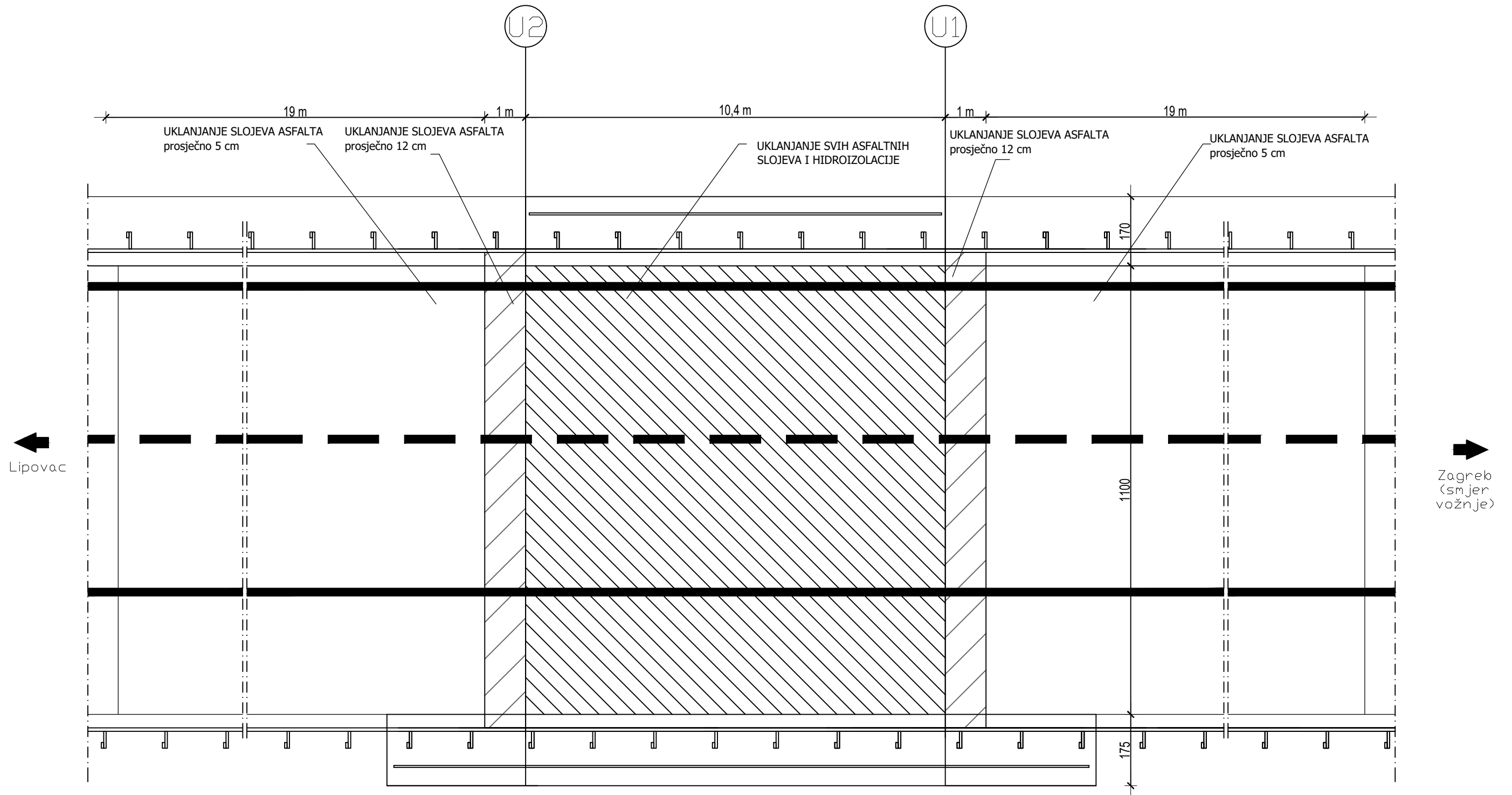

INVESTITOR: <b>HRVATSKE AUTOCESTE d.o.o.</b> 10 000 ZAGREB, ŠIROLINA 4	KNJIGA:	SADRŽAJ:  <b>FAZA UGRADNJE - DESNO</b>	 <small>INSTITUT IGH ZAVOD ZA PROJEKTIRANJE</small>
NARUČITELJ: <b>HRVATSKE AUTOCESTE d.o.o.</b> 10 000 ZAGREB, ŠIROLINA 4	GLAVNI PROJEKTANT: mr.sc. KRUNOSLAV MAVAR, dipl.ing.grad.	BROJ PROJEKTA: <b>72180-IZV-215/21</b>	
GRAĐEVINA: <b>MOST ŽUTICA U KM 66+174 NA AUTOCESTI A3</b>	 <small>G 595</small>	MJERILO: <b>1:100</b>	DATUM: <b>svibanj, 2021.</b>
VRSTA PROJEKTA: <b>IZVEDBENI GRAĐEVINSKI PROJEKT</b>		SURADNIK: <b>DOROTEA SREMEC, mag. ing. aedif.</b>	ARHIVSKI BROJ: <b>IZV-215/21</b>
		OZNAKA DOKUMENTA: <b>72180-IZP-215-21_MOST ŽUTICA</b>	

TLOCRT KOLNIKA LIJEVOG  
OBJEKTA



INVESTITOR: HRVATSKE AUTOCESTE d.o.o. 10 000 ZAGREB, ŠIROLINA 4	KNJIGA:	SADRŽAJ: TLOCRT KOLNIKA - LIJEVO	 INSTITUT IGZ ZAVOD ZA PROJEKTIRANJE
NARUČITELJ: HRVATSKE AUTOCESTE d.o.o. 10 000 ZAGREB, ŠIROLINA 4	GLAVNI PROJEKTANT: mr.sc. KRUNOSLAV MAVAR, dipl.ing.građ.  G 595	BROJ PROJEKTA: 72180-IZV-215/21	
GRADEVINA: MOST ŽUTICA U KM 66+174 NA AUTOCESTI A3	SURADNIK: DOROTEJA SREMEC, mag. ing. aedif.	MJERILO: 1:100	DATUM: svibanj, 2021.
VRSTA PROJEKTA: IZVEDBENI GRAĐEVINSKI PROJEKT		ARHIVSKI BROJ: IZV-215/21	BROJ PRILOGA: 6.
		OZNAKA DOKUMENTA: 72180-IZP-215-21_MOST ŽUTICA	

TLOCRT KOLNIKA DESNOG  
OBJEKTA

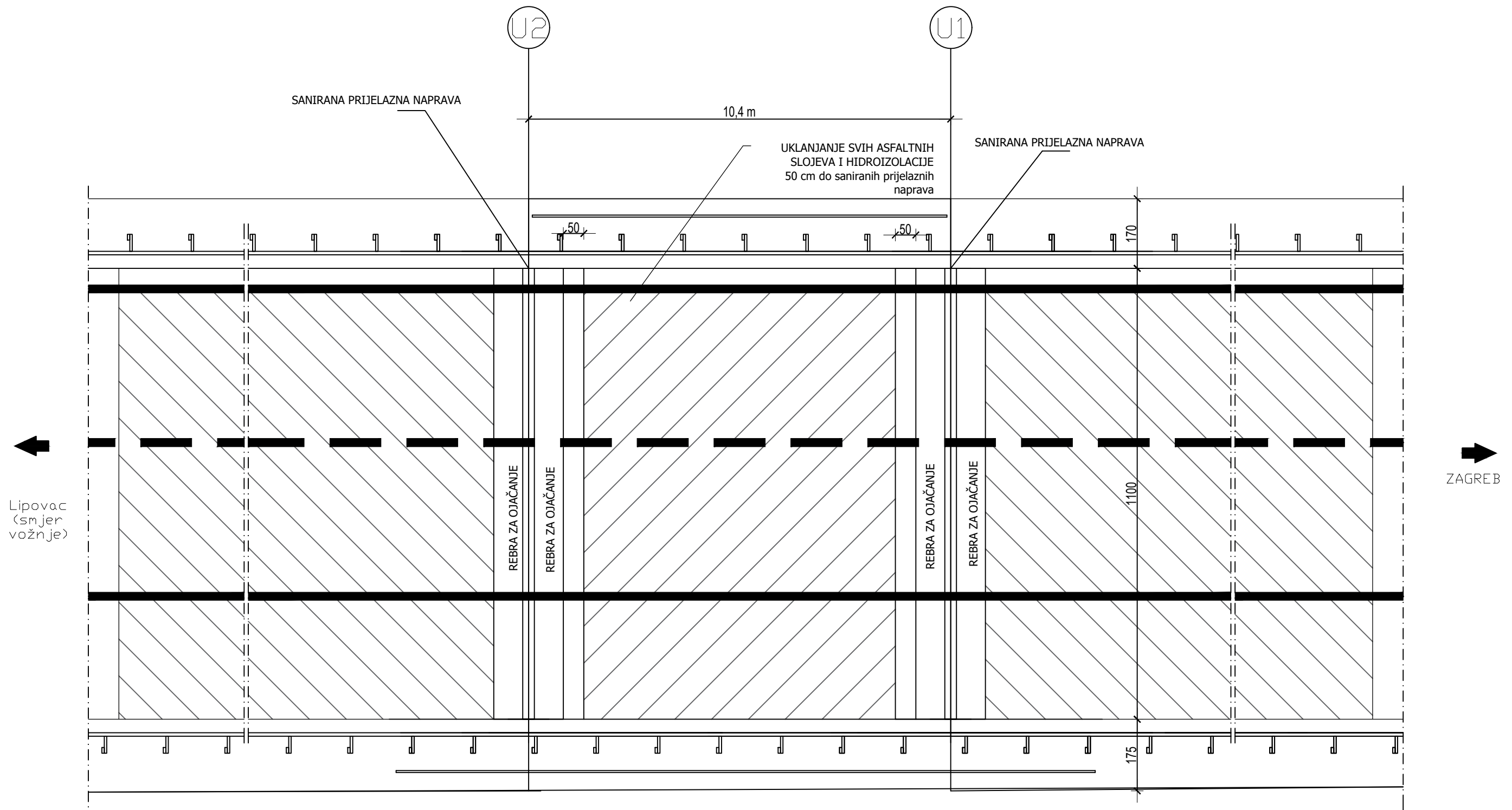

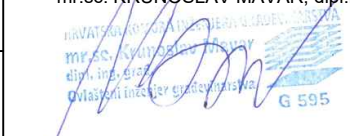
INVESTITOR: <b>HRVATSKE AUTOCESTE d.o.o.</b> 10 000 ZAGREB, ŠIROLINA 4	KNJIGA:	SADRŽAJ: <b>TLOCRT KOLNIKA - DESNO</b>	 INSTITUT IGH ZAVOD ZA PROJEKTIRANJE
NARUČITELJ: <b>HRVATSKE AUTOCESTE d.o.o.</b> 10 000 ZAGREB, ŠIROLINA 4	GLAVNI PROJEKTANT: mr.sc. KRUNOSLAV MAVAR, dipl.ing.grad.	BROJ PROJEKTA: <b>72180-IZV-215/21</b>	
GRADEVINA: <b>MOST ŽUTICA U KM 66+174 NA AUTOCESTI A3</b>	 G 595	MJERILO: <b>1:100</b>	DATUM: <b>svibanj, 2021.</b>
VRSTA PROJEKTA: <b>IZVEDBENI GRAĐEVINSKI PROJEKT</b>		SURADNIK: <b>DOROTEJA SREMEC, mag. ing. aedif.</b>	ARHIVSKI BROJ: <b>IZV-215/21</b>
		OZNAKA DOKUMENTA: <b>72180-IZP-215-21_MOST ŽUTICA</b>	

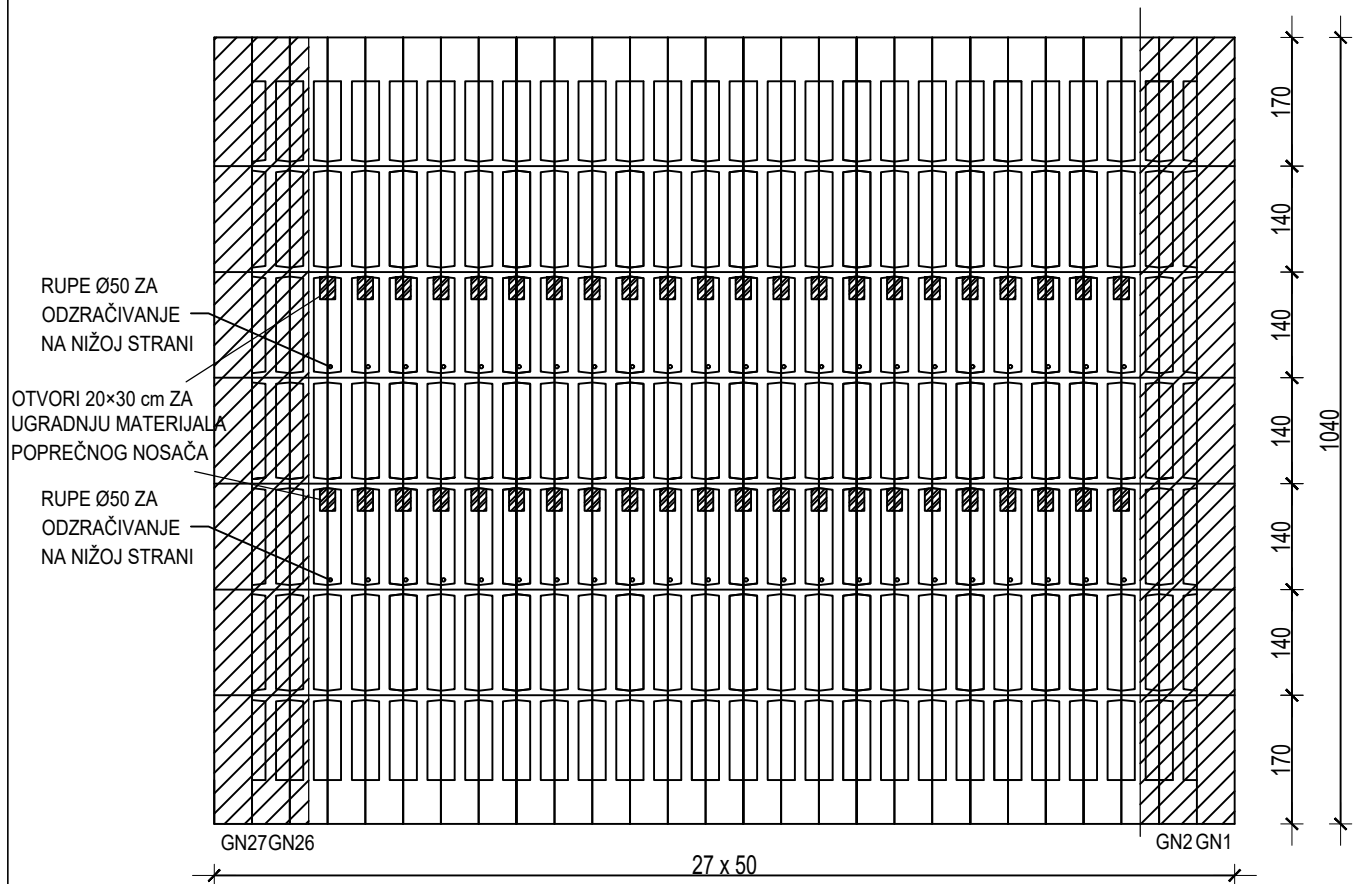

Tlocrt  
1:100

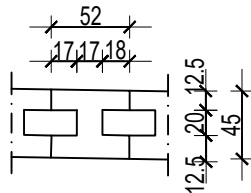

Presjek nosača\*  
1:50





\*dimenzije su okvirne, preuzete iz dostupne dokumentacije!

INVESTITOR: HRVATSKE AUTOCESTE d.o.o. 10 000 ZAGREB, ŠIROLINA 4	KNJIGA:	SADRŽAJ: TLOCRT RASPONSKE KONSTRUKCIJE - UKLANJANJE	
NARUČITELJ: HRVATSKE AUTOCESTE d.o.o. 10 000 ZAGREB, ŠIROLINA 4	GLAVNI PROJEKTANT: mr.sc. KRUNOSLAV MAVAR, dipl.ing.grad.	BROJ PROJEKTA: 72180-IZV-215/21	
GRAĐEVINA: MOST ŽUTICA U KM 66+174 NA AUTOCESTI A3		MJERILO: 1:100	DATUM: svibanj, 2021.
VRSTA PROJEKTA: IZVEDBENI GRAĐEVINSKI PROJEKT		SURADNIK: DOROTEJA SREMEC, mag. ing. aedif.	ARHIVSKI BROJ: IZV-215/21
		OZNAKA DOKUMENTA: 72180-IZP-215-21_MOST ŽUTICA	

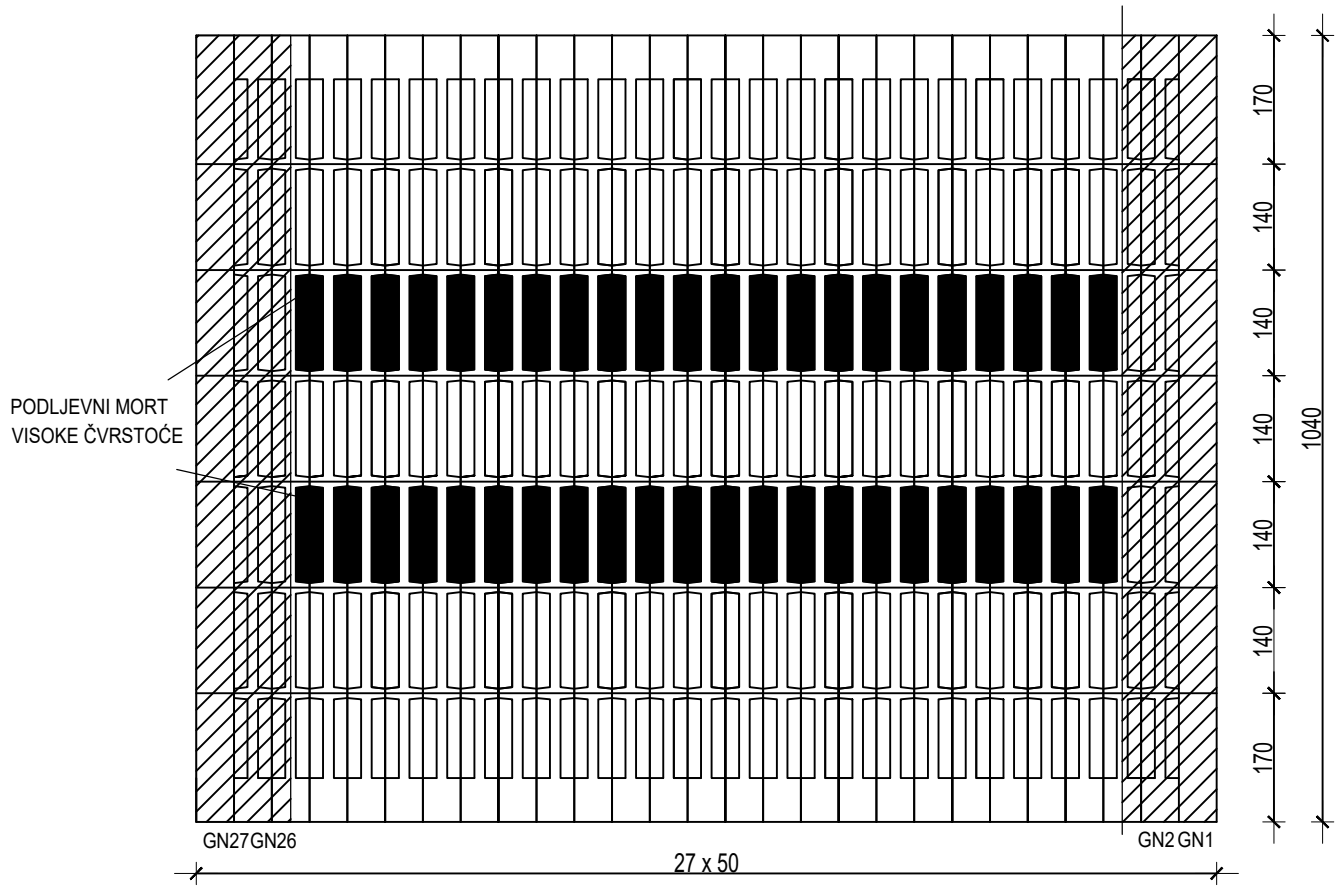

Tlocrt



INVESTITOR: <b>HRVATSKE AUTOCESTE d.o.o.</b> 10 000 ZAGREB, ŠIROLINA 4	KNJIGA:	SADRŽAJ: <b>TLOCRT RASPONSKE                  KONSTRUKCIJE - UGRADNJA</b>	
NARUČITELJ: <b>HRVATSKE AUTOCESTE d.o.o.</b> 10 000 ZAGREB, ŠIROLINA 4	GLAVNI PROJEKTANT: mr.sc. KRUNOSLAV MAVAR, dipl.ing.grad. 	BROJ PROJEKTA: <b>72180-IZV-215/21</b>	
GRAĐEVINA: <b>MOST ŽUTICA U KM 66+174 NA                  AUTOCESTI A3</b>	SURADNIK: DOROTEA SREMEC, mag. ing. aedif.	MJERILO: <b>1:100</b>	DATUM: <b>svibanj, 2021.</b>
VRSTA PROJEKTA: IZVEDBENI GRAĐEVINSKI PROJEKT		ARHIVSKI BROJ: <b>IZV-215/21</b>	BROJ PRILOGA: <b>9.</b>
		OZNAKA DOKUMENTA: 72180-IZP-215-21_MOST ŽUTICA	

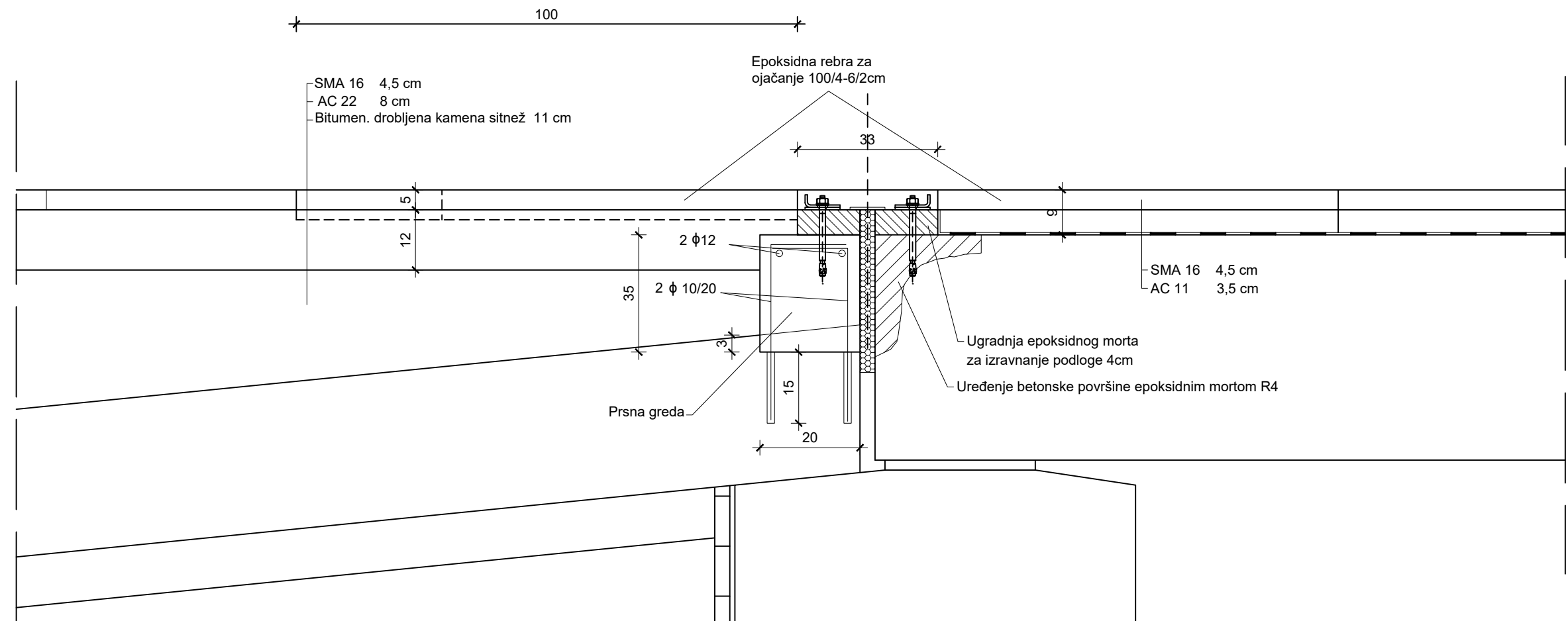

IZVEDBA REBARA ZA OJAČANJE  
ASFALTOG KOLNIKA, MJ 1:20

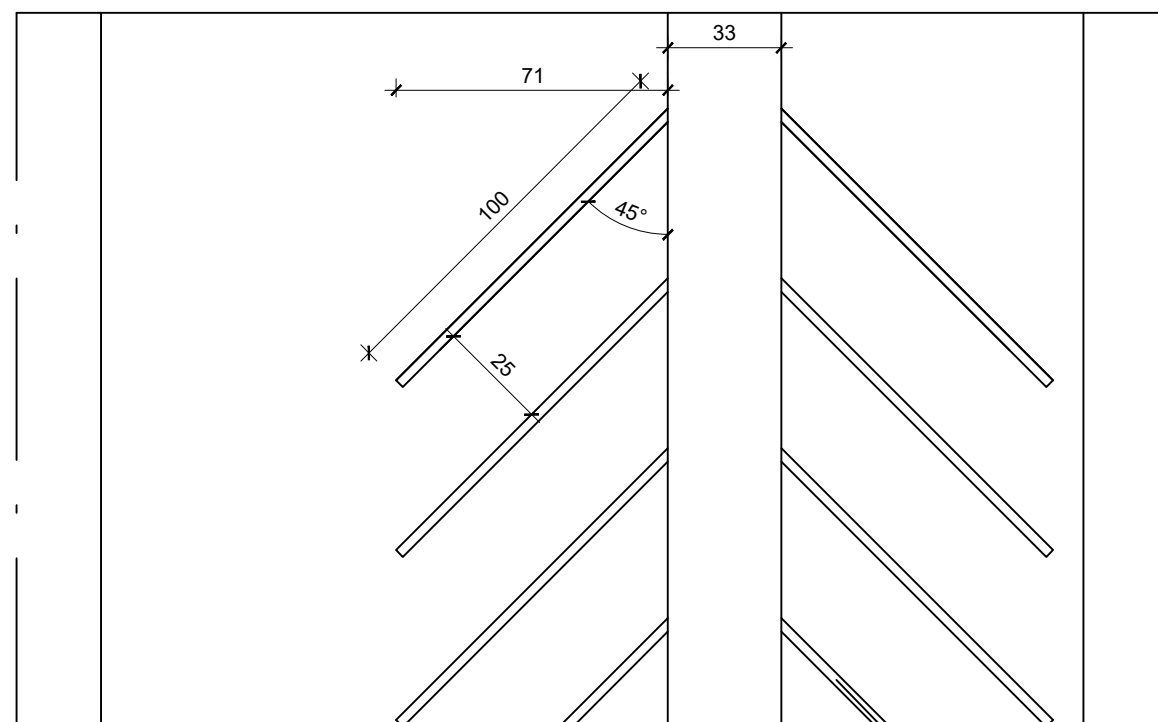

PRIJELAZNA PLOČA

KOLNIČKA PLOČA





prijelazna  
naprava

masa za  
ispunu rebara

INVESTITOR: HRVATSKE AUTOCESTE d.o.o. 10 000 ZAGREB, ŠIROLINA 4	KNJIGA:	SADRŽAJ: DETALJ - UGRADNJA HOLKERA	 INSTITUT IGH ZAVOD ZA PROJEKTIRANJE
NARUČITELJ: HRVATSKE AUTOCESTE d.o.o. 10 000 ZAGREB, ŠIROLINA 4	GLAVNI PROJEKTANT: mr.sc. KRUNOSLAV MAVAR, dipl.ing.grad	BROJ PROJEKTA: 72180-IZV-215/21	
GRADEVINA: MOST ŽUTICA U KM 66+174 NA AUTOCESTI A3	 G 595	MJERILO: 1:10, 1:20	DATUM: svibanj, 2021.
VRSTA PROJEKTA: IZVEDBENI GRADEVINSKI PROJEKT		SURADNIK: DOROTEA SREMEC, mag. ing. aedif.	ARHIVSKI BROJ: IZV-215/21
		OZNAKA DOKUMENTA: 72180-IZP-215-21_MOST ŽUTICA	

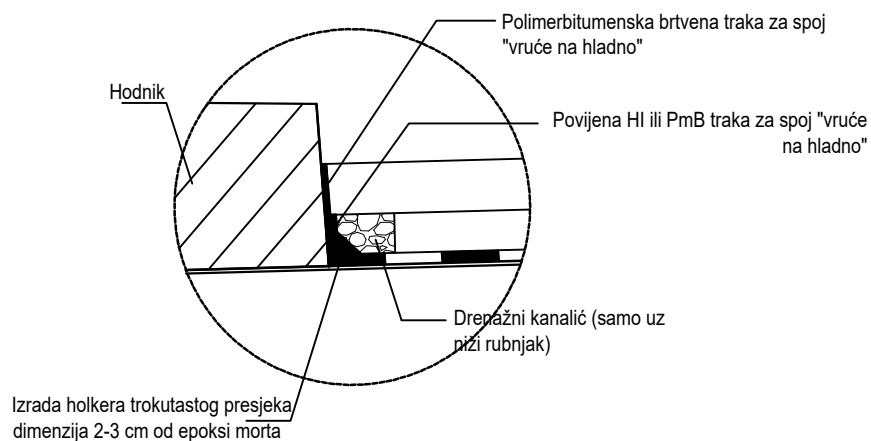
### DETALJ HOKKERA



<b>INVESTITOR:</b> HRVATSKE AUTOCESTE d.o.o. 10 000 ZAGREB, ŠIROLINA 4	<b>KNJIGA:</b>	<b>SADRŽAJ:</b> DETALJ - UGRADNJA HOKKERA	
<b>NARUČITELJ:</b> HRVATSKE AUTOCESTE d.o.o. 10 000 ZAGREB, ŠIROLINA 4	<b>GLAVNI PROJEKTANT:</b> mr.sc. KRUNOSLAV MAVAR, dipl.ing.grad. 	<b>BROJ PROJEKTA:</b> 72180-IZV-215/21	
<b>GRADEVINA:</b> MOST ŽUTICA U KM 66+174 NA AUTOCESTI A3	<b>SURADNIK:</b> DOROTEJA SREMEC, mag. ing. aedif.	<b>MJERILO:</b> 1:100	<b>DATUM:</b> svibanj, 2021.
<b>VRSTA PROJEKTA:</b> IZVEDBENI GRADEVINSKI PROJEKT		<b>ARHIVSKI BROJ:</b> IZV-215/21	<b>BROJ PRILOGA:</b> 11.
		<b>OZNAKA DOKUMENTA:</b> 72180-IZP-215-21_MOST ŽUTICA	